

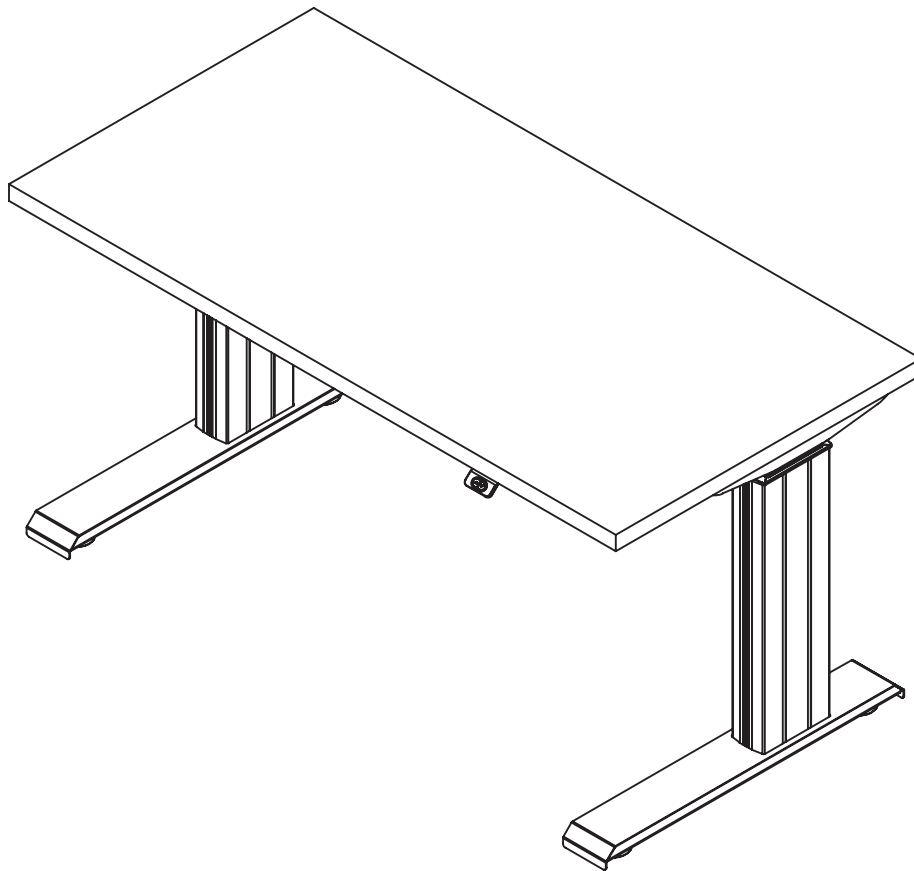

Bay Product Development

NewHeights™ Series 4 Elegante XT 2-Leg Workstation
Warranty: raproducts.com/warranty



READ ALL INSTRUCTIONS BEFORE USING THIS PRODUCT.



**USE THIS PRODUCT ONLY AS INSTRUCTED.
FAILURE TO COMPLY WITH ALL INSTRUCTIONS AND WARNINGS
MAY RESULT IN SERIOUS PROPERTY DAMAGE OR BODILY INJURY.**

Basic Safety Instructions

- 1. Intended Use.** This Product is exclusively designed for use as indoor office furniture in compliance with all instructions and safety warnings in the user manual. Any different use, or use extending beyond the intended use, may result in property damage or bodily injury and is prohibited. This Product should not be used, operated or maintained with additional components not authorized by K&A Manufacturing, Inc.

BY USING THIS PRODUCT OR ANY FEATURE OF THIS PRODUCT, YOU AGREE TO COMPLY WITH ALL PRODUCT TERMS AND POLICIES, INCLUDING WITHOUT LIMITATION ANY SAFETY WARNINGS AND INSTRUCTIONS, PROVIDED BY K&A MANUFACTURING, INC. AND ITS AFFILIATES. K&A MANUFACTURING, INC. SHALL ASSUME NO LIABILITY FOR ANY DAMAGE OR INJURY CAUSED BY USE OF THE PRODUCT A) IN VIOLATION OF ANY SAFETY WARNINGS OR INSTRUCTIONS; B) NOT AUTHORIZED BY K&A MANUFACTURING, INC.; OR C) BY EVENTS BEYOND K&A MANUFACTURING, INC.'S CONTROL.



**DO NOT SIT, STAND OR CRAWL ON OR UNDER THE PRODUCT.
MAKE SURE NO OBSTACLES ARE IN THE PRODUCT'S PATH.
MAKE SURE ALL CORDS ARE LONG ENOUGH TO ACCOMMODATE ANY CHANGE IN HEIGHT.
DO NOT USE ATTACHMENTS NOT RECOMMENDED BY THE MANUFACTURER.**

- 2. Electrical Height Adjustment.** The height of this Product may be adjusted electronically. Contact with electrical voltage may cause serious injury and death. Only use the Product in compliance with these instructions. This Product should not be used in environments with high levels of humidity or moisture.

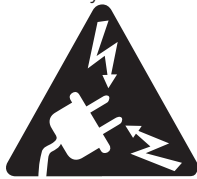

**KEEP CORDS AND ELECTRICAL COMPONENTS AWAY FROM HEAT AND LIQUIDS.
DO NOT OPEN ANY OF THE COMPONENTS: CONTROL BOX OR KEYPAD.
DO NOT USE WITH A DAMAGED PLUG OR CORD.
DO NOT INSERT ANYTHING INTO ANY SEAM OR OPENING.**

- 3. Setup and Use.** This Product should only be used and operated in good condition. When in use, no one should sit, stand or crawl on or under the Product. There is a danger of crushing, shearing, injury or damage. Keep the entire range of motion of the Product clear of all obstacles. Devices and object on the Product can tip over, fall or be crushed by the Product.



**KEEP HANDS AND FINGERS CLEAR.
KEEP ALL OBSTACLES CLEAR OF THE PRODUCT'S PATH.**

- 4. Users.** This Product is not intended for use with children, individuals with restricted physical, sensory or mental capabilities, or individuals who lack experience or knowledge, unless they are supervised by a person who is responsible for their safety or they have received instructions from a person who is responsible for their safety concerning how the Product must be used. Children should be closely supervised to ensure that they do not play with the Product and its height adjustment mechanism to avoid risk of physical injury or electric shock.



KEEP CHILDREN AWAY FROM THE PRODUCT, ITS CONTROL UNITS, AND KEYPADS.

Tools Required for Assembly

- A. Power Driver with Adjustable Torque
- B. #2 Phillips Head Driver Bit
- C. #2 Square Head Drive Bit
- D. Level
- E. 3/16" Allen Wrench

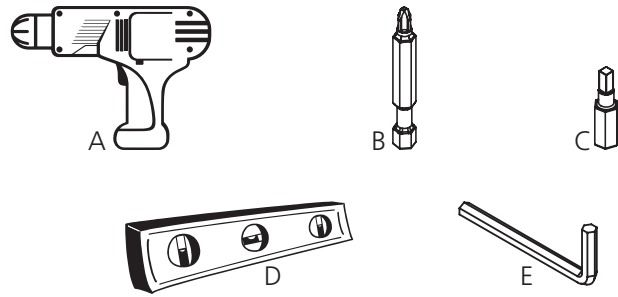

Hardware and Tools Included for Assembly (may have extra)

- F. 3/4" 10 x 5/8" Round Washer Head Wood Screw x21
- G. 5/16" x 18-3/8" Button Socket Cap Screw x4
- H. 1/4 Blk Flat Washer x2
- I. 1/4-20 x 1/2 Blk Ph Hd Machine Screw x2
- J. Cable Clamp 3/16 Black x4
- K. 8 x 3/4" Pan Head Wood Screw x4

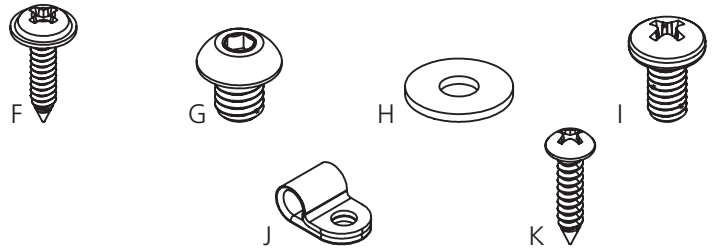

Elegante Parts

- L. Wire Management (size varies) x1
- M1. Two Button Up/Down Switch x1
- M2. Four Button Programmable Up/Down Switch x1
Optional - *If you have a programmable switch, please refer to the installation instructions included with the switch.*
- N. Control Box for Two Motors x1
- O. Power Cord x1
- P. Power Strip x1
- Q. Left Leg x1
- R. Right Leg x1

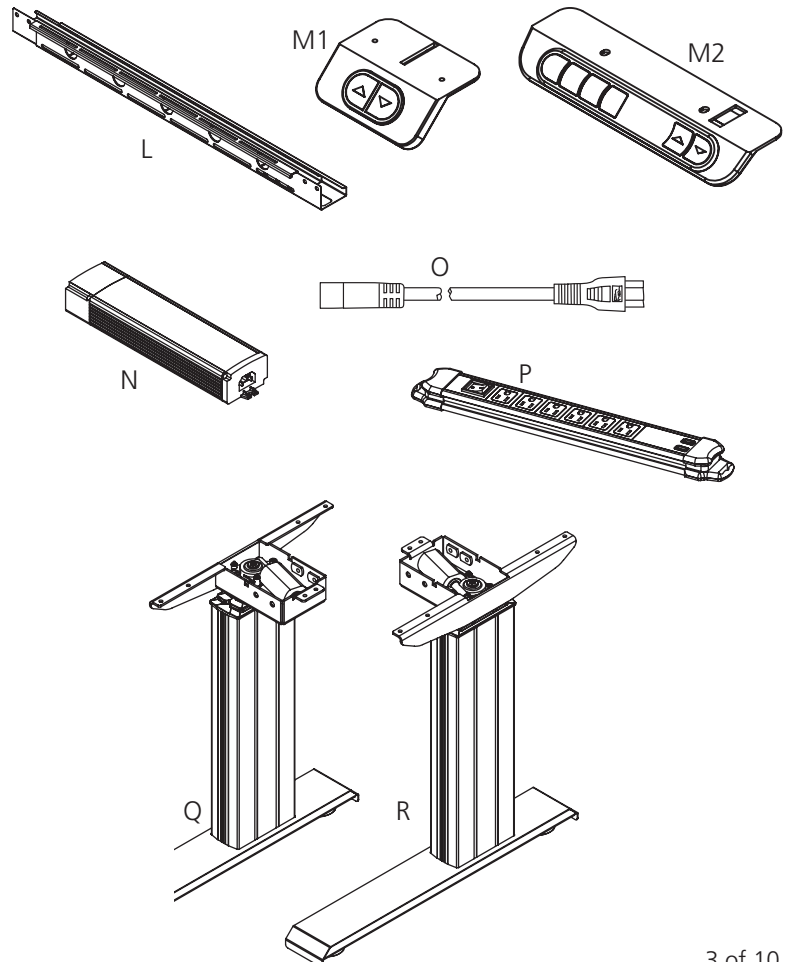

Step 1

- Lay the worksurface on a protected surface with the pilot holes facing up. Set the legs on the worksurface and align them over the pilot holes.
- Slide the wire management apart and attach four machine screws with a 3/16" Allen wrench into the legs. **Do not tighten.**

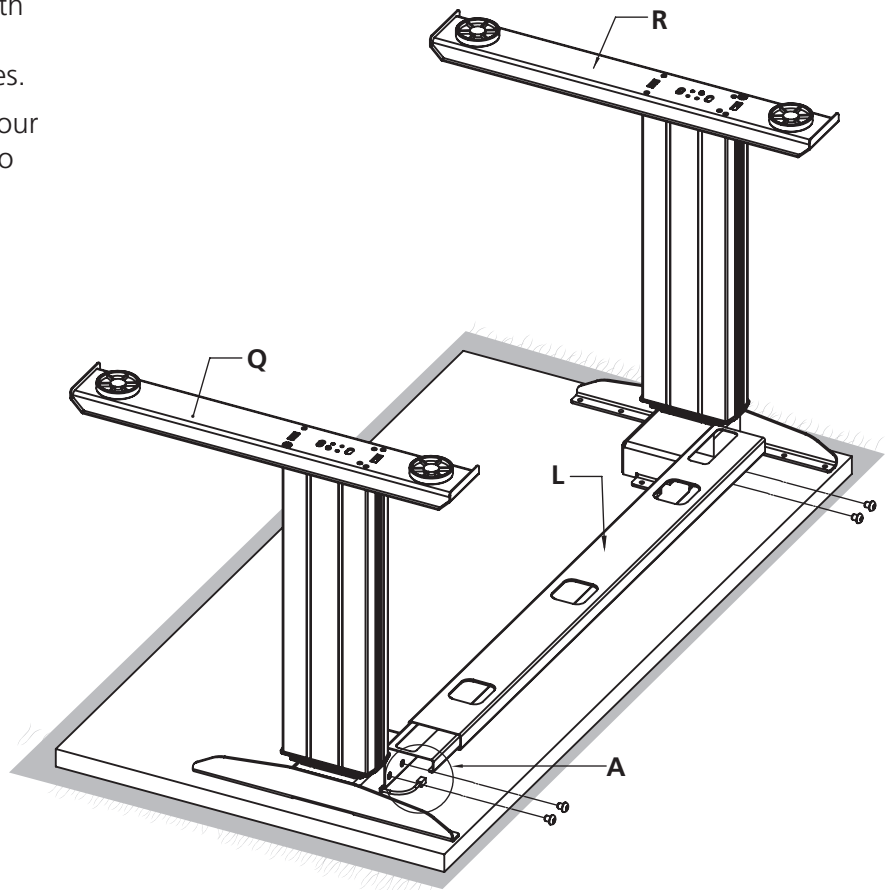
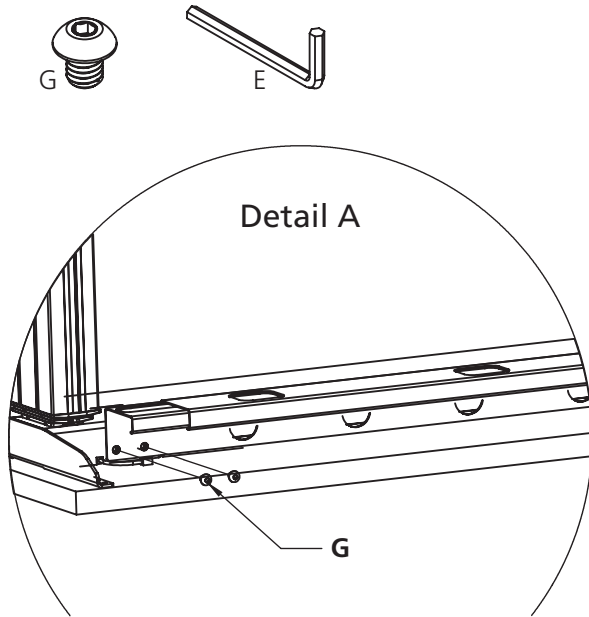

Step 2

- **If your table comes with optional cross supports for added stability, please refer to the included instructions and install.**
- If your table does not come with cross supports, continue to Step 3.

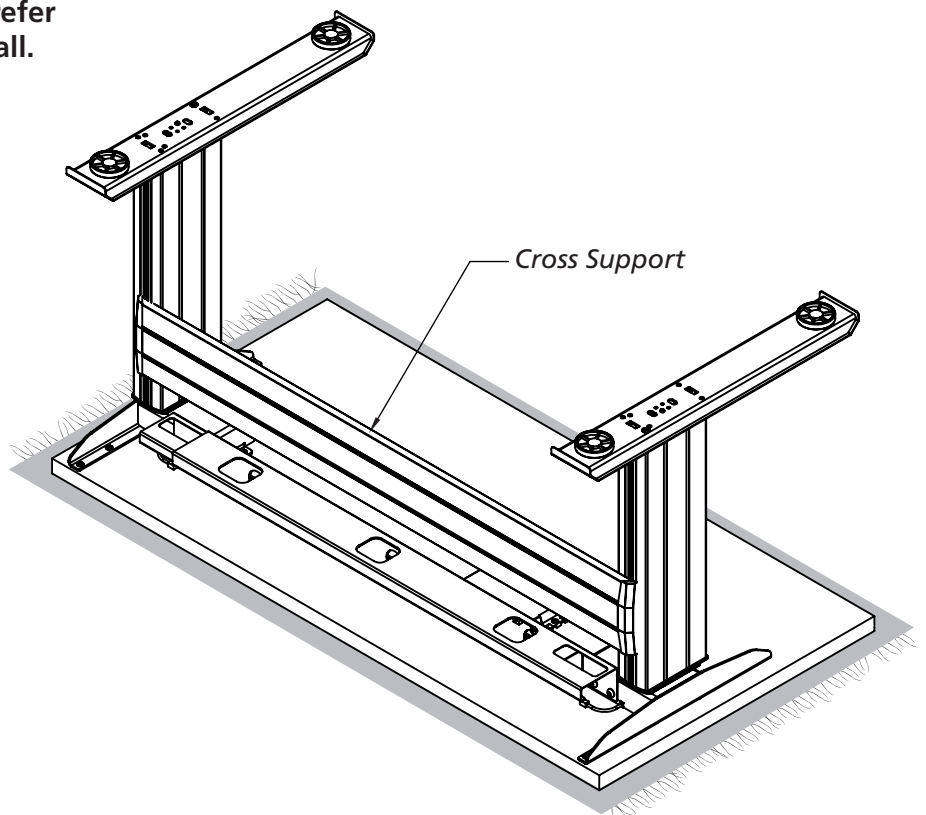

Step 3

- Install the wood screws through the legs and into the worksurface pilot holes.
Do not tighten.

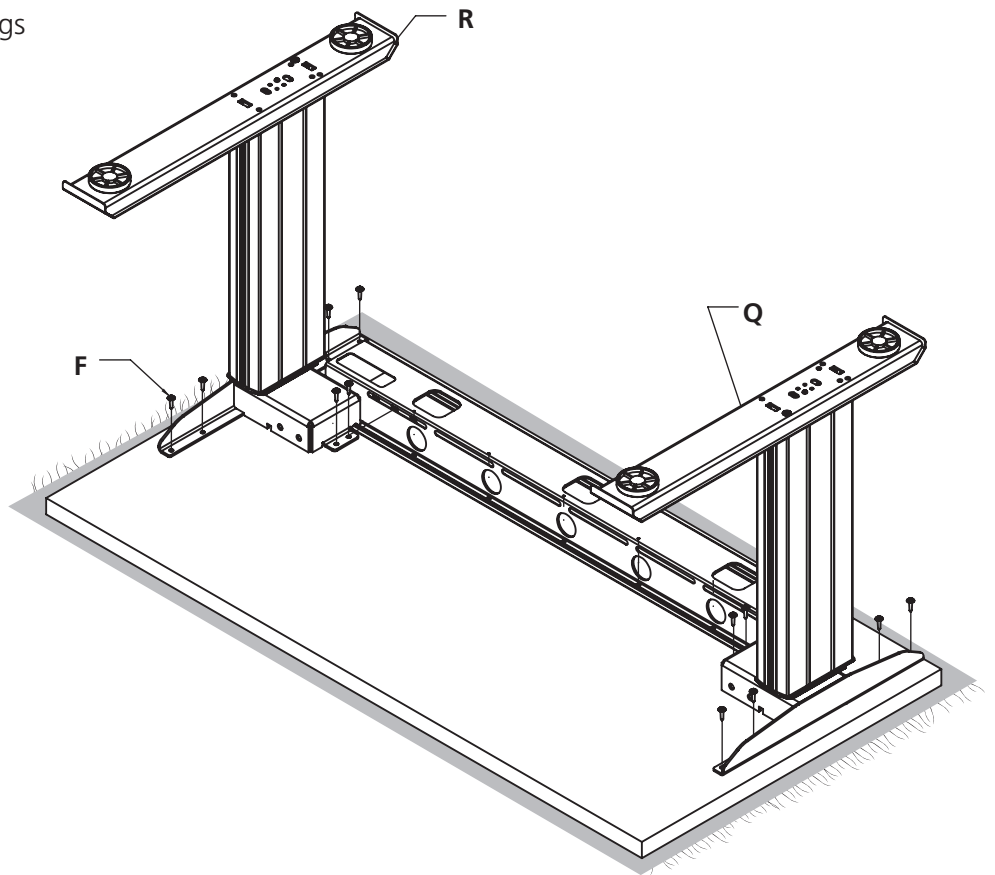
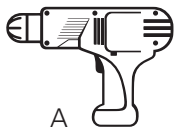

Step 4

- Insert the machine screws and washers through the slots of the wire management and into any two cage nuts.

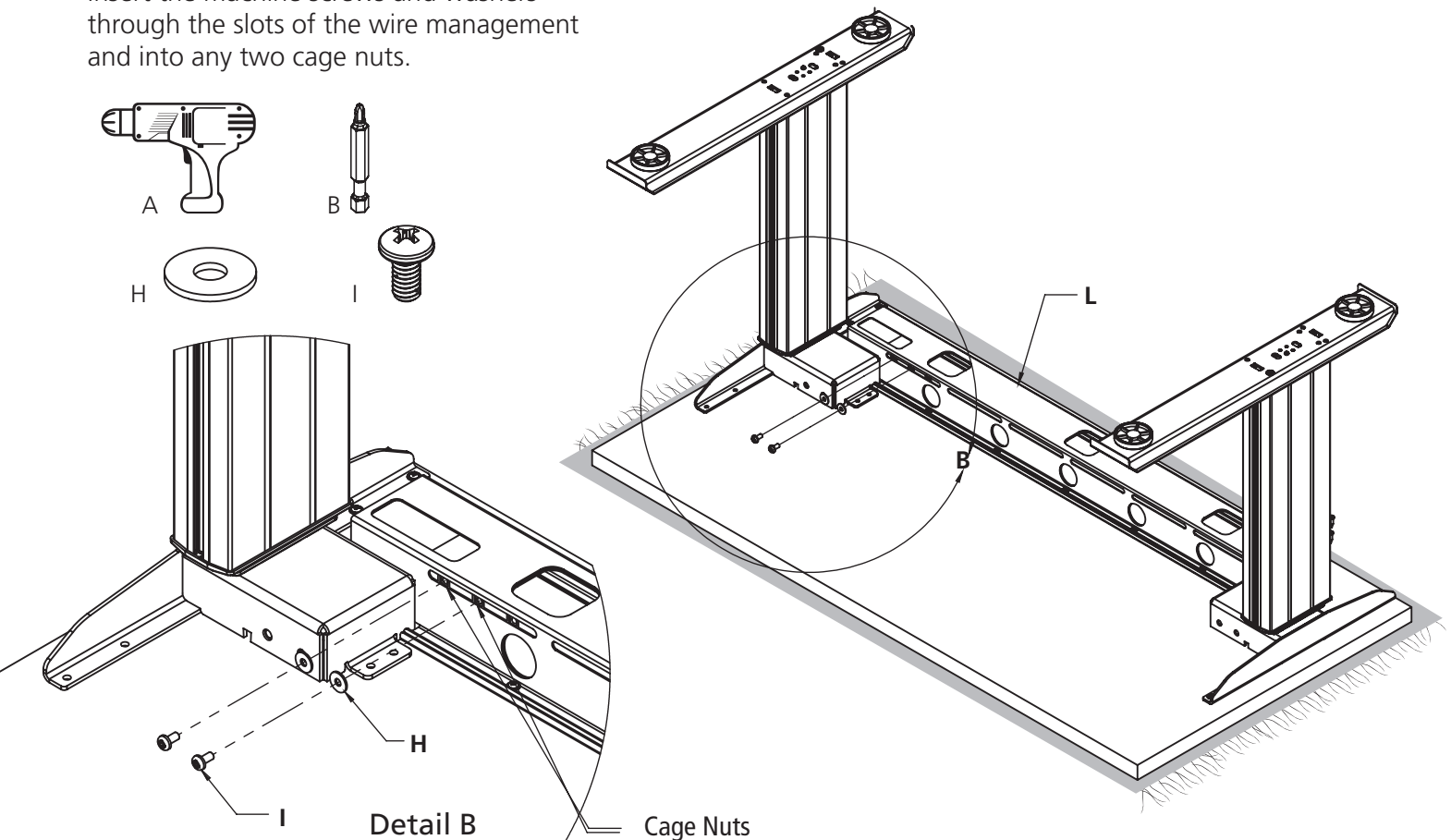
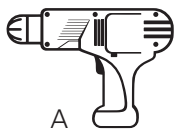

Step 5

- Install the wood screws through the wire management holes and into the worksurface. Pilot holes are not provided, however the screws are self drilling.
- **Fully tighten all screws and bolts.**

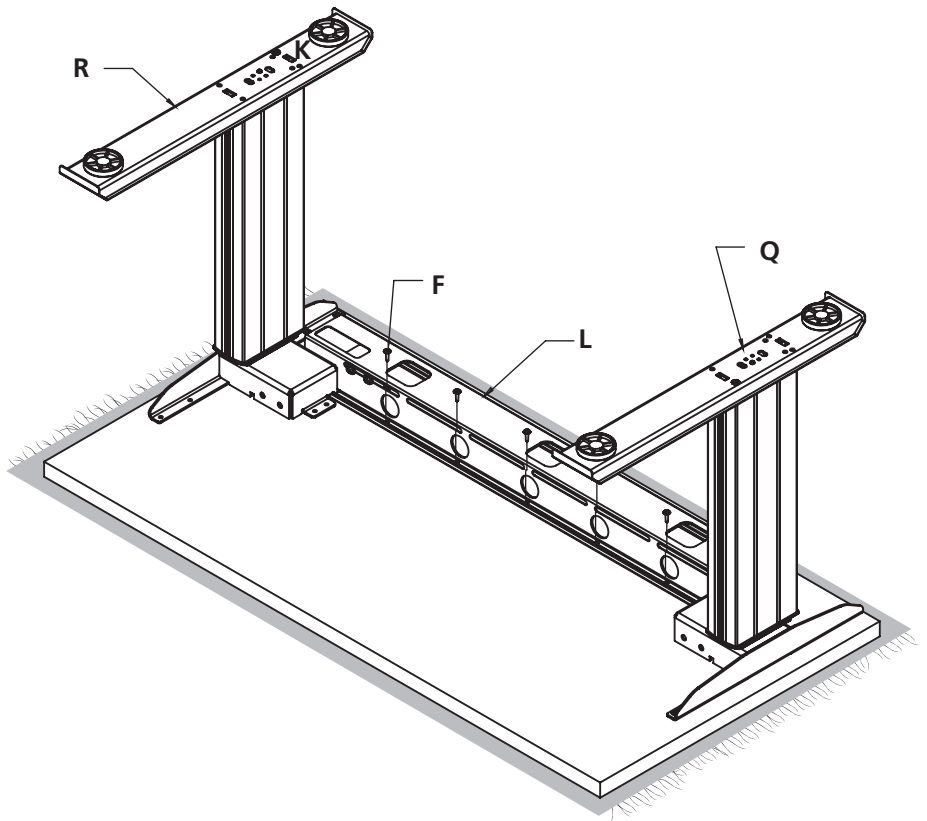
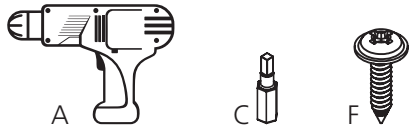

Step 6

- Install the switch, cable clamps, power strip, and control box. Pilot holes are only provided for the control box and switch.

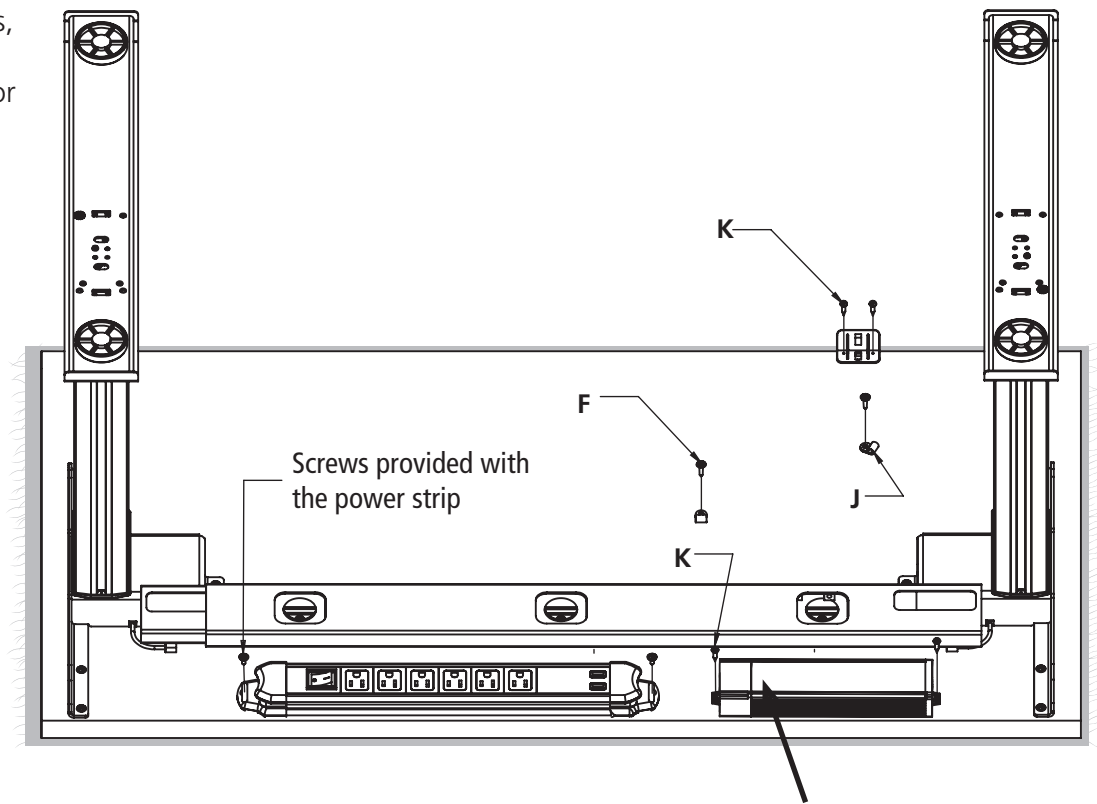
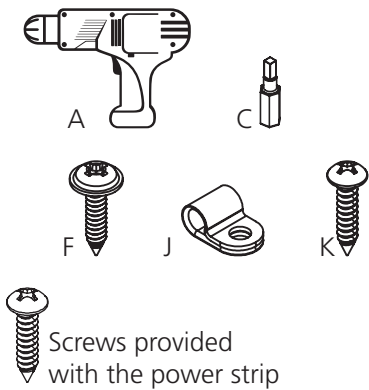
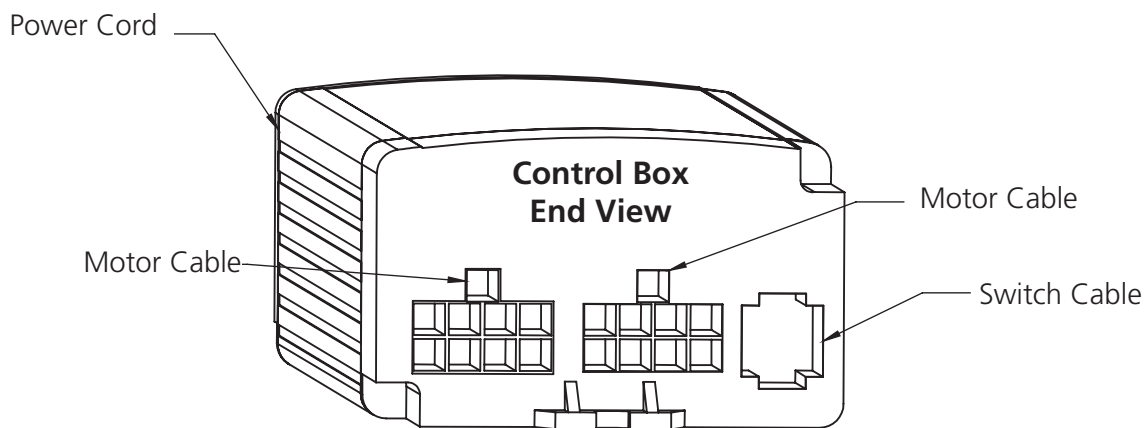
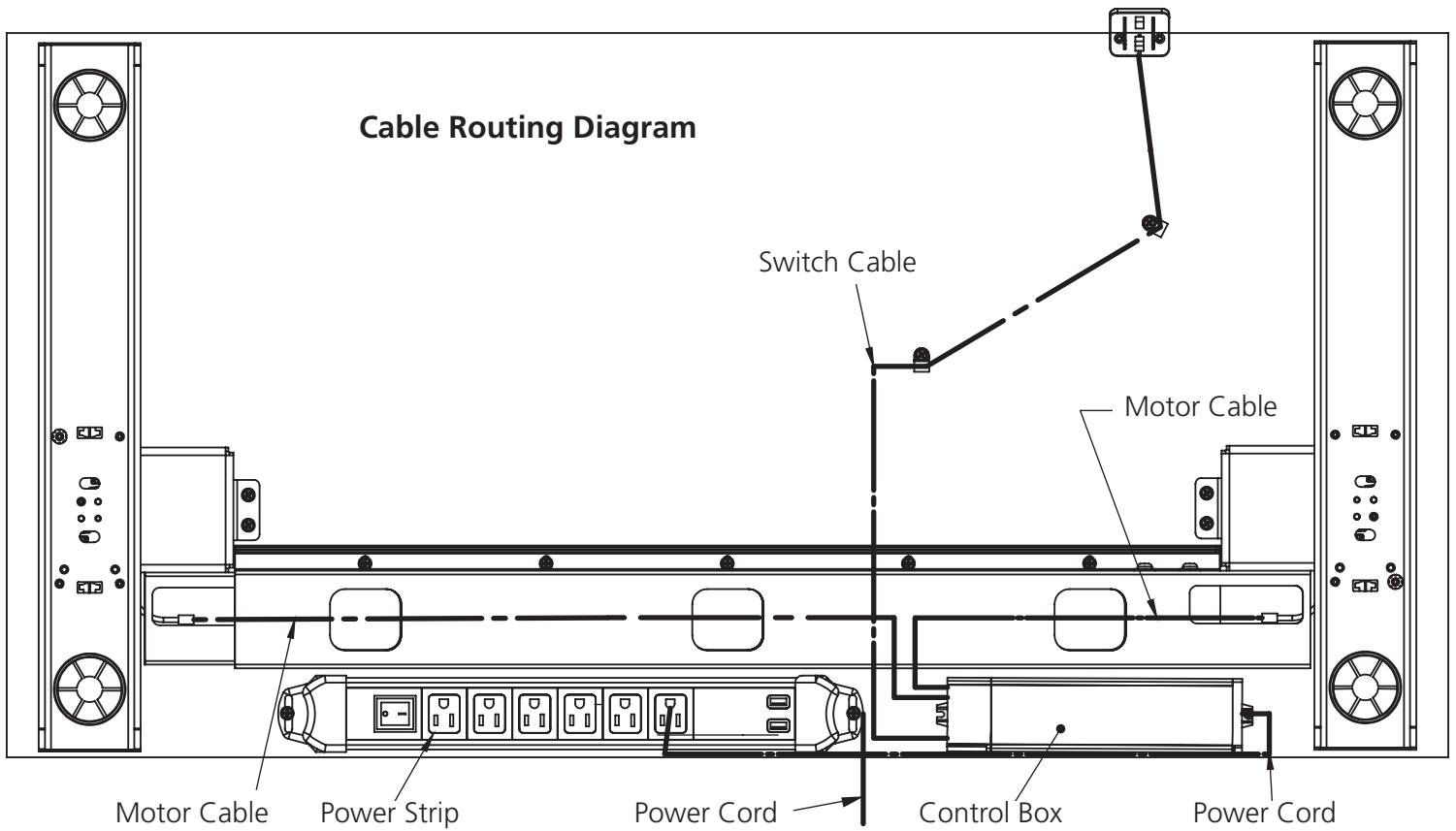

Table will **NOT** operate unless the control box is screwed tight into the table without any play.

Step 7



Caution:



For the safety of the user and the workstation; the control box contains an internal sensor that is sensitive to movement, vibration, and collision. For faultless operation, ensure all cables, electronics, and accessories are cable managed and secured. Excessive load or weight must be distributed evenly. Failure to follow these guidelines may cause intermittent functionality.

Standard Switch Save for Reference

Start Up Procedure:



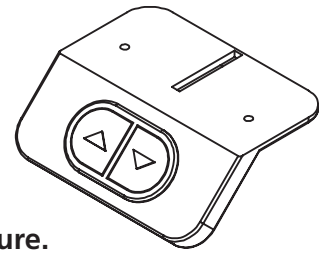









- Plug the power cord into a standard 110V receptacle. A power surge protector is recommended.
 - Press the down arrow until the worksurface reaches its lowest position.
 - The workstation is ready for use.
 - **If the table is not functioning normally or has lost power, perform the reset procedure.**
-













Reset Procedure:

- Unplug the unit from the wall for 10 seconds.
 - Clear all obstructions from the travel path of the desk.
 - Plug the unit back in the wall.
 - Press and hold the down arrow key until the table reaches its lowest position.
-

Add Container Stops:

- Move the table  to the upper or lower desired height.
 - Rapidly press  4 times. You will hear a musical tone. 
 - Rapidly press  2 times. A musical tone plays two times.  
 - To **add** the **upper** container stop press  A musical tone plays two times.  
 - To **add** the **lower** container stop press  A musical tone plays two times.  
-

Remove Container Stops:

- Move the table  to the upper or lower **preset** height.
 - Rapidly press  4 times. You will hear a musical tone. 
 - Rapidly press  2 times. A musical tone plays two times.  
 - To **delete** the **upper** container stop press  You will hear a musical tone. 
 - To **delete** the **lower** container stop press  You will hear a musical tone. 
-

Optional Programmable Switch (full instructions packaged with switch)

Start Up Procedure:

- Plug the power cord into a standard 110V receptacle. A power surge protector is recommended.
- Press the down arrow until the worksurface reaches its lowest position.
- The workstation is ready for use.
- **If the table is not functioning normally, or has lost power, perform the reset procedure.**

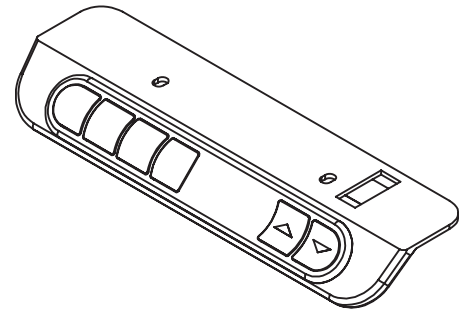

Reset Procedure:

- Unplug the unit from the wall for 10 seconds.
- Clear all obstructions from the travel path of the desk.
- Plug the unit back in the wall.
- Press and hold the down arrow key until the table reaches its lowest position

See Packaged Instructions for Programmable Options

Mechanical Reset Mode

If the table is unresponsive, uneven, or not functioning properly, perform a manual reset.











User settings are not reset in this process.

There are three methods to reset a workstation:

Reset Method A















1. Clear all obstructions from the travel path of the workstation
2. Disconnect the power to the control box for 30 seconds.
3. Reconnect the power
4. Press and hold the  until the workstation has reached its lowest possible position.

Reset Method B (4 button programmable switch required)

1. Clear all obstructions from the travel path of the workstation
2. Quickly press  +  +  +  to enter the menu mode.
3.  is displayed and you will hear a musical tone. 
4. Press the   to navigate the menu.
5. Navigate to the  display
6. Press the  button to enter or accept
7. Press and hold the  until the workstation has reached its lowest possible position.

The workstation is now ready to operate

Reset Method C - 2 Button Switch

1. Clear all obstructions from the travel path of the workstation
2. Quickly press  +  +  +  to enter the menu mode.
3. You will hear a musical tone. 
4. Press  +  +  + 
5. You will reach the limit adjustment menu and hear four musical tones.    
6. Press and hold the  until the workstation has reached its lowest possible position.

The reference is re-calibrated, the table should be leveled and the height indication should be correct.