

IST48

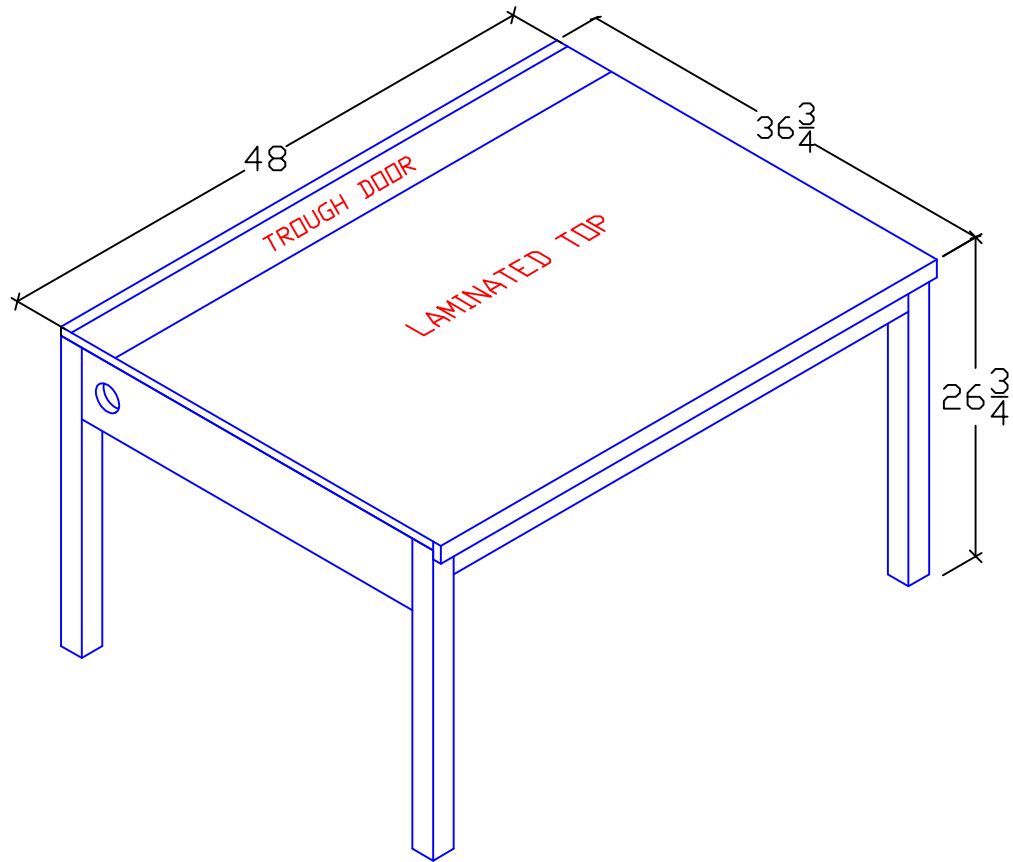

DRAWING IST48

CUSTOMER INFORMATION:

BEFORE ORDERING; PLEASE MEASURE TO MAKE SURE FURNITURE HAS ROOM TO GO THROUGH ALL HALLWAYS, DOORS, STAIRS, ELEVATORS, ETC..TO REACH IT'S INTENDED DESTINATION.

BY SIGNING THE DRAWING(S) SHOWN THE CUSTOMER ACCEPTS THE FURNITURE ITEM(S) AS SHOWN IN ITS ENTIRETY INCLUDING ALL SIZES AND COMPONENTS.

ANY DRAWING ALTERATIONS REQUIRE THAT A NEW DRAWING AND QUOTE BE GENERATED BY ACI FURNITURE. FINAL DRAWING MUST BE SIGNED BY THE CUSTOMER.
PRIOR TO ORDERING

CUSTOMER SIGNATURE IS REQUIRED FOR ALL CUSTOM DRAWINGS BEFORE PRODUCTION.

DRAWING APPROVAL SIGNATURE
THIS DRAWING IS THE SOLE
PROPERTY OF ACI INDUSTRIES

CUSTOMER SIGNATURE IS REQUIRED
FOR ALL CUSTOM DRAWINGS BEFORE PRODUCTION
DRAWING APPROVAL SIGNATURE
